

ALLOWANCE	MARK	DATE	DESCRIPTION OF REVISION	APPROVED
UNDER 3	$\pm 0.1$	. .		
3 TO 6	$\pm 0.2$			
6 TO 18	$\pm 0.3$	. .		
18 TO 50	$\pm 0.4$			
50 OVER	$\pm 0.5$	. .		

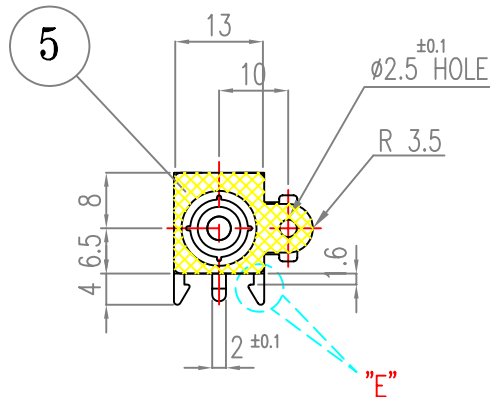

"E" DETAIL 2/1

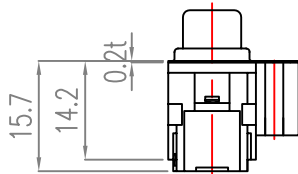
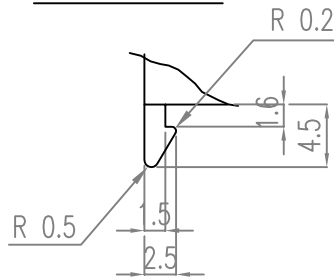

SCHEMATIC

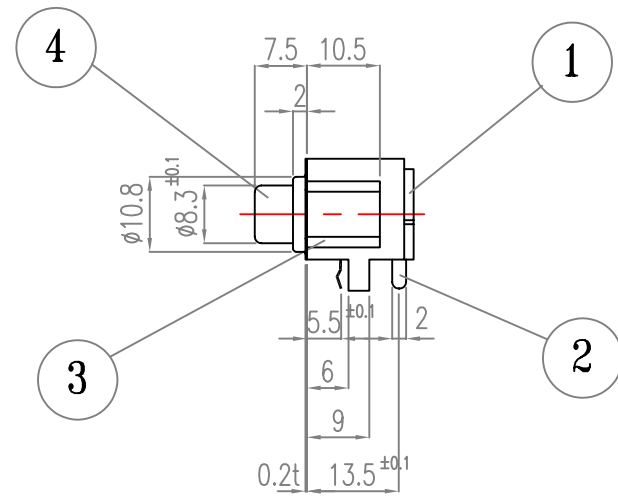
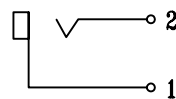

PCB-MTG

(Solder Surface)

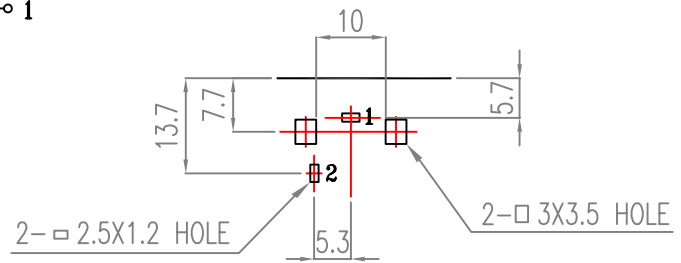

5	GND-PLATE(1P)	C2600 1-0 0.2t	1	2P348	AU-PLATING
4	CAP-GROUND	C2600 1-0 0.4t	1	1P146	AU-PLATING
3	COVER	ACETAL	1	2M755	BLACK
2	PIN-S	C2680 H 0.5t	1	2P147	NI-PLATING
1	BASE	ACETAL	1	2M719	YELLOW
NO	PART NAME	MATERIAL	QUANTITY	PART NO	REMARKS

Vimex International Corp.  
800-227-0075

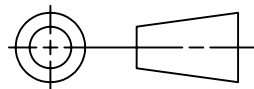

SCALE

1/1

DIMENSION

m/m

REVISION	DRAWING	CHECKED	APPROVED
1.0	L.M.S		
	2001.01.08	2001.01.08	2001.01.08

NAME TITLE
PIN JACK BOARD(1P)
DRAWING NUMBER
JC010126DG